

Limited One-Year Warranty Thompson Rifles & Handguns

This "LIMITED ONE-YEAR WARRANTY" has been drafted to comply with the MAGNUSON-MOSS WARRANTY FEDERAL TRADE COMMISSION IMPROVEMENT ACT which is effective for goods manufactured on or after December 31, 1976.

KAHR ARMS / AUTO-ORDNANCE warrants that this firearm was originally manufactured free of defects in material or workmanship. For one year from date of purchase of the original purchaser, KAHR ARMS agrees to correct any defect in this firearm for the original purchaser by repair or replacement (with same or comparable quality model). A service and/or handling charge may be applied.

THIS WARRANTY IS VOID IF THE FIREARM HAS BEEN ABUSED, MISUSED, DAMAGED BY ACCIDENT, FIRED WITH HANDLOADED AND/OR RELOADED OR IMPROPER AMMUNITION OR WITH AN OBSTRUCTION IN THE BARREL, OR DAMAGED THROUGH FAILURE TO PROVIDE REASONABLE AND NECESSARY MAINTENANCE AS DESCRIBED IN THIS MANUAL. THIS WARRANTY DOES NOT APPLY TO NORMAL WEAR OF ANY PARTS, INCLUDING METAL, WOOD, PLASTIC, RUBBER AND OTHER MATERIAL'S SURFACE FINISH OR IF UNAUTHORIZED REPAIR AND/OR ALTERATION HAS BEEN PERFORMED.

The terms of the Warranty cannot be changed except in writing by an officer of KAHR ARMS.

Wholesalers and Dealers (unless a KAHR ARMS authorized Warranty repair station) are not authorized to make any Warranty repair or adjustment on behalf of KAHR ARMS.

This Warranty gives only the original retail purchaser specific legal rights. Other rights may also be available which may vary from state to state.

Should repair be required for this firearm, contact Kahr Customer Service at Tel: **(508) 795-3919** or Fax: (508) 795-7046 and request a "Return Authorization" Number. Provide full details of the defect or malfunction, date of purchase and dealer from whom the firearm was purchased. Then, send the unloaded firearm, prepaid via UPS AIR or FEDEX for handguns or UPS GROUND for rifles, with a copy of the sales receipt and "Return Authorization" Number to:

**Kahr Arms – Service Dept.
130 Goddard Memorial Drive
Worcester, MA 01603**

E-mail Address: service@kahr.com
Web Address: www.kahr.com / www.tommygun.com

OWNER'S MANUAL

TO BE USED FOR THOMPSON SEMI-AUTO MODELS

Maker of the world famous
"TOMMY GUN"

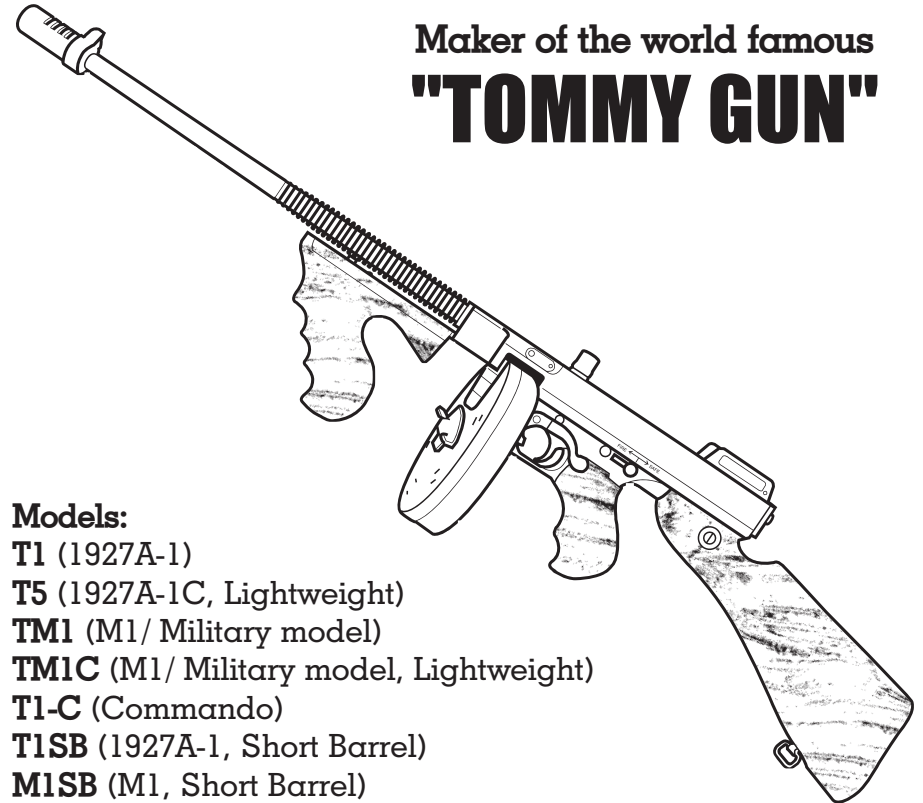

Models:

T1 (1927A-1)

T5 (1927A-1C, Lightweight)

TM1 (M1/ Military model)

TM1C (M1/ Military model, Lightweight)

T1-C (Commando)

T1SB (1927A-1, Short Barrel)

M1SB (M1, Short Barrel)



As the owner of a firearm, you must undertake the full-time responsibility of safe firearm handling for your own safety and the safety of those around you. Before handling any firearm read and understand the information contained in its owner's manual.



Be certain this owner's manual is available for reference and is kept with this firearm if transferred to another party. If the manual is lost or misplaced, write directly to Kahr Arms for a free replacement copy.

SAFETY AND SAFE FIREARM HANDLING IS EVERYONE'S RESPONSIBILITY.

Auto-Ordnance Corporation

Corporate Offices: P.O. Box 220, Blauvelt, NY 10913

Wholesale: 845-735-4500 / Fax: 845-735-4610

Dealer Sales: 561-656-1288 / Fax: 561-656-1549

Factory: 130 Goddard Memorial Drive, Worcester, MA 01603

Consumer Sales & Service: 508-795-3919 / Fax: 508-795-7046

Web Address: www.kahr.com / www.tommygun.com



TABLE OF CONTENTS

Contents	Page
USER SAFETY WARNINGS & RESPONSIBILITY	3-4
LOCKING DEVICES	5
NOMENCLATURE (T1 & T5)	6
NOMENCLATURE (TM1 & TM1C)	7
NOMENCLATURE (T1SB & M1SB)	8
OPERATION OF SAFETY	9
OPERATION OF THE BOLT LOCK	9
AMMUNITION	10
MAGAZINES - STICK AND DRUM	11-13
LOADING AND FIRING THE THOMPSON	14
DISASSEMBLY OF THE SEMI-AUTO THOMPSON FOR ROUTINE CLEANING ..	15-16
REASSEMBLY OF THE SEMI-AUTO THOMPSON	17
STICK MAGAZINE INSPECTION AND CARE	18
CARE AND CLEANING	19
SERVICE INSTRUCTIONS - PARTS INFORMATION & ORDERS	20
SHIPPING FIREARMS FOR SERVICE	21
THE BASIC RULES OF SAFE FIREARMS HANDLING	22-23
PARTS LIST & EXPLODED VIEW, MODELS: T1, T5, T1-C and T1SB	24-25
PARTS LIST & EXPLODED VIEW, MODELS: TM1, TM1C and M1SB	26-27
WARRANTY	Back Cover

THOMPSON MODELS AND SPECIFICATIONS included in this manual

Model: T1 Model: T5 Model: T1SB	Model: TM1 / TM1C Model: M1SB	Model: T1-C (Commando)
Caliber:45 ACP	Caliber: 45 ACP	Caliber: 45 ACP
Barrel:16.5", Finned & Threaded (with compensator 18", T1 & T5) 10.5", Finned & Threaded (with compensator 12", T1SB)	Barrel: ...16.5", Smooth (TM1 & TM1C) 10.5", Smooth (M1SB)	Barrel:16.5", Finned & Threaded (with compensator 18")
Length:41" overall (T1 & T5) 35" overall (T1SB)	Length:38" overall (TM1 & TM1C) 32" overall (M1SB)	Length:41" overall
Weight:13 lbs. (T1) 9.5 lbs. (T5, Aluminum Receiver) 12 lbs. (T1SB)	Weight:11.5 lbs. (TM1) 9.0 lbs. (TM1C, Aluminum Receiver) 10.5 lbs. (M1SB)	Weight:13 lbs.
Sight:Blade front, open rear adjustable	Sight:Blade front, fixed battle rear	Sight:Blade front, open rear adjustable
Stock:Walnut fixed stock, vertical foregrip	Stock:Walnut fixed stock and horizontal foregrip	Stock:Black finish stock & forend
Magazine:30 Shot stick	Magazine:30 Shot stick*	Magazine:30 Shot stick
	*Will not accept drum magazines	

USER SAFETY WARNINGS & RESPONSIBILITY

IMPORTANT "SAFETY WARNINGS" -- NOTE THE SYMBOL



These safety warnings are for your protection as well as the safety of others. Disregarding information in this manual may result in serious injury or death.



STOP! Do not attempt to load or use any firearm until you read and understand the information contained in its owner's manual. Before handling your firearm, you should learn how it operates and how to maintain it. This includes knowing its basic parts, how the manual safety and other safety features operate, how to safely open and close the action and how to safely load and unload ammunition from the firearm. Improper use and handling is dangerous and could cause severe injury or death to you or those around you. All users of the firearm must become thoroughly familiar with the instructions in this manual.

Be certain this owner's manual is available for reference and is kept with this firearm if transferred to another party. If the manual is lost or misplaced, write directly to Kahr Arms for a free replacement copy.



As the owner of a firearm, you must undertake the full-time responsibility of safe firearm handling for your own safety and the safety of those around you:

- Keep all firearms and ammunition out of the reach of children.
- Store your firearms and ammunition separately.
- Never store a loaded firearm.
- Never leave a loaded firearm unattended.
- Never transport a loaded firearm in a vehicle.



REMEMBER: A firearm's safety lever is a mechanical device which can never replace safe firearm handling. Safe firearm handling depends on you!



Always point the muzzle of your firearm in a safe direction, regardless of whether the firearm is loaded or unloaded. You should become thoroughly familiar with the function and operation of this firearm and the instructions supplied with it.



Always treat every firearm as if it were loaded. Give your firearm to someone with the action open and safety in the "on" (safe) position after you verify the firearm is unloaded. Insist on the same procedure when receiving a firearm from someone else. Learn the location of all the safety features of your firearm and how they operate.

You have a responsibility to obtain proper training on how to use and maintain your firearm. Certified and reputable safety courses and instructions are offered by The National Rifle Association (NRA) as well as by state and local organizations. You also have a responsibility to know and obey all local, state and federal laws governing the use, possession and transportation of firearms.



To protect yourself and others from injury, use the correct ammunition referenced by the markings on the receiver. Thompson firearms are designed, manufactured and proof tested to recommended Sporting Arms and Ammunition Manufacturers Institute (SAAMI) standards for factory loaded ammunition. We specifically disclaim responsibility for any damage or injury whatsoever occurring in connection with, or as the result of, the use in Thompson firearms of cartridges other than those for which the firearm was originally chambered. Additionally, we disclaim any responsibility for damage or injury which results from any modifications or changes that are not a part of the firearm as delivered from the factory.



Learn how to clean your firearm thoroughly and make certain no oil, grease or other materials are blocking the barrel. Obstructions of any kind can cause damage to the firearm resulting in personal injury.

Practice proper firearm maintenance and safety. Make sure all exposed metal surfaces are coated with a thin film of oil, especially after being exposed to damp weather. (See proper section of this manual for cleaning instructions). Before using after storage, follow complete instructions stated in this manual for familiarization with the firearm. A thorough inspection should be performed before shooting the firearm.



Wear eye and ear protection when shooting. Shooting without proper ear protection can cause hearing damage. The use of eye protection during any type of shooting is important to protect your vision.



Never climb or jump over an obstacle with a loaded firearm. Never pull a firearm toward you by the muzzle. Never shoot towards a flat, hard surface or water. Always be sure of your target and what is beyond it.



When handling your firearm, never allow fingers or any object to touch the trigger until you are ready to shoot.



The safety should always be in the "on" (safe) position until you are ready to shoot. It is a mechanical device and should never be used as an excuse for careless handling or unsafe practices.



Make sure you read, understand and follow the firearm safety rules that are listed in this manual.



The use of a locking device or safety lock is only one aspect of responsible firearm storage. Firearms should be stored unloaded and locked in a location that is both separate from their ammunition and inaccessible to children and other unauthorized persons.



LOCKING DEVICES

This firearm was originally sold with a key-operated locking device. While it can help provide secure storage for your unloaded firearm, any locking device can fail. All guns are designed to fire if they are loaded and the trigger is pulled. Therefore, never install the locking device inside the trigger guard or in any way that it can possibly pull the trigger! Do not leave the keys in the lock.

The ultimate responsibility for secure storage of any firearm must depend upon its owner and his or her individual circumstances. Guns should be securely stored unloaded, in a secure location, separate from their ammunition.



WARRANTY IS VOIDED IF PIVOT PLATE IS REMOVED WITH FRAME ON RECEIVER.



IT IS IMPERATIVE THAT YOU KEEP THIS FIREARM LOCKED IN A SECURE PLACE AND TAKE OTHER STEPS NECESSARY TO LIMIT THE POSSIBILITY OF THEFT OR ACCIDENT. FAILURE TO TAKE REASONABLE PREVENTIVE STEPS MAY RESULT IN INNOCENT LIVES BEING LOST AND, IN SOME CIRCUMSTANCES MAY RESULT IN YOUR LIABILITY FOR THESE DEATHS.

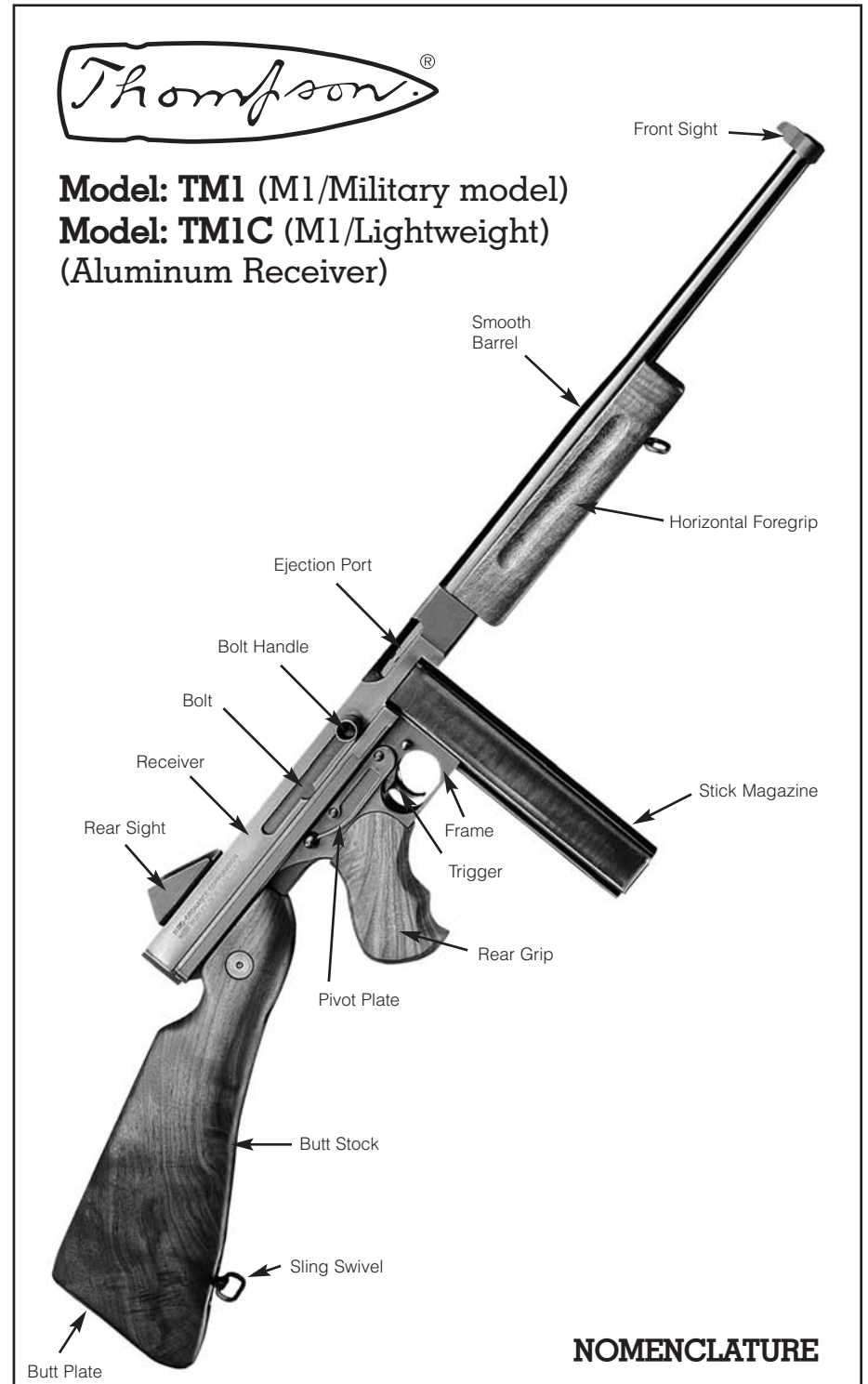
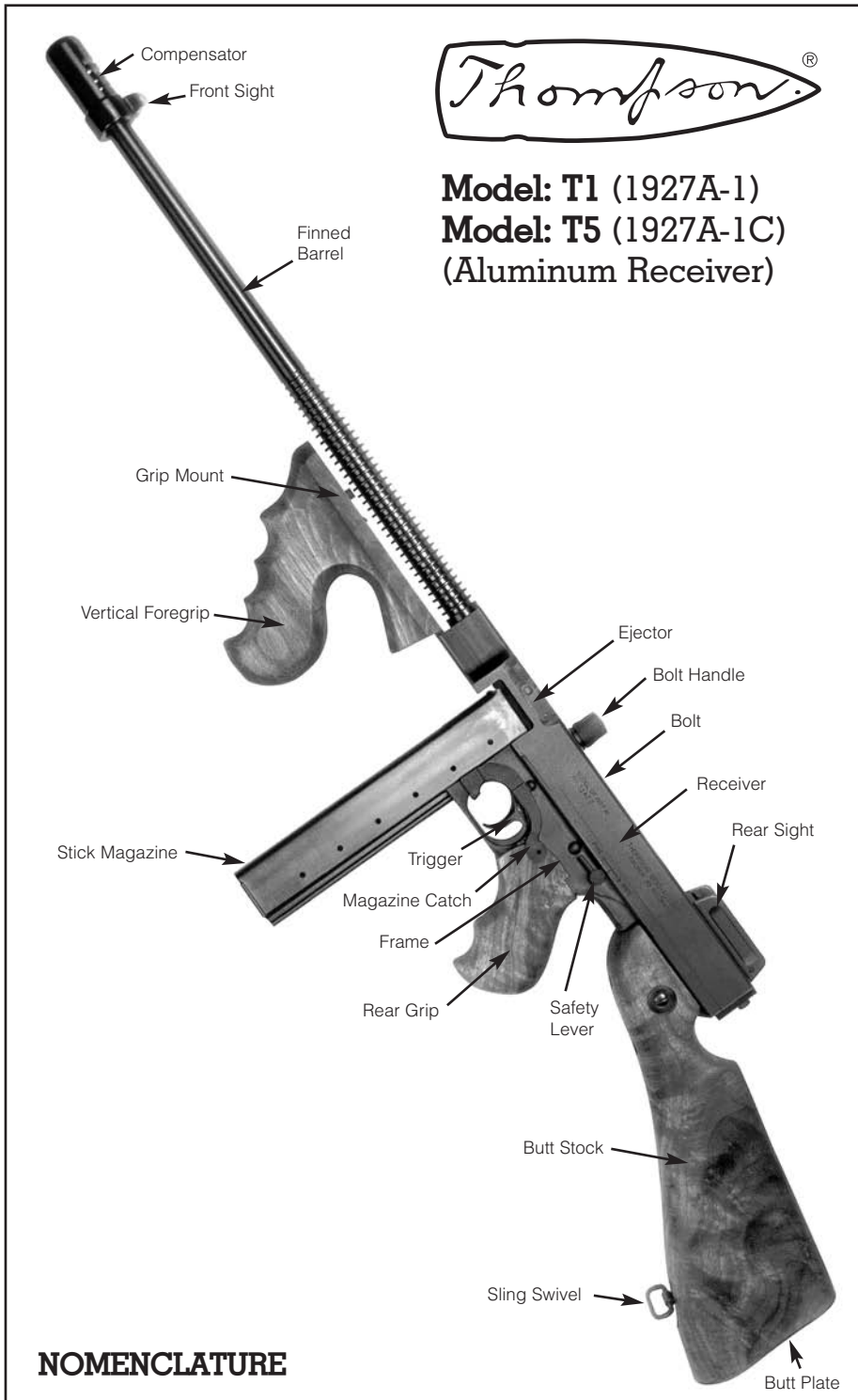

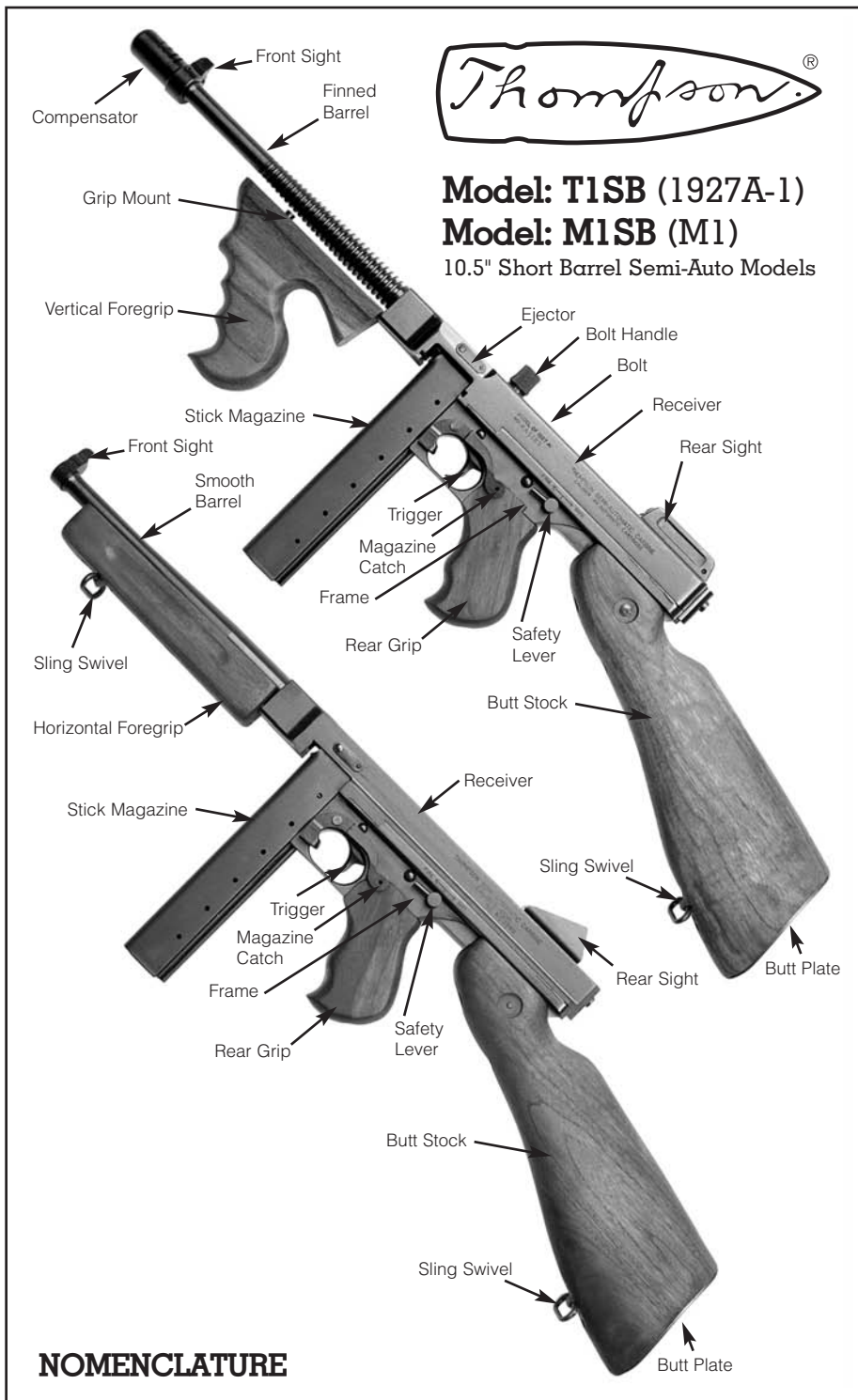

Operation of Safety



DO NOT PULL BOLT BACK WITH SAFETY ON OR DAMAGE TO THE FIRING PIN MAY RESULT AS WELL AS PERSONAL INJURY.

The manual safety lever is located on the frame above the rear grip and must be moved manually by the shooter. To put the safety in the "SAFE" (on) position, the safety lever must be rotated fully rearward beneath the word "SAFE" indicated on the frame. To put the safety in the "FIRE" (off) position, the safety lever must be rotated fully forward in the direction of the muzzle beneath the word "FIRE" indicated on the frame.



ALWAYS SET FIREARM ON SAFE POSITION WHEN NOT IN USE. REMEMBER, A FIREARM'S MANUAL SAFETY IS A MECHANICAL DEVICE WHICH CAN NEVER REPLACE SAFE FIREARM HANDLING AND STORAGE PRACTICES.



SAFETY ON



SAFETY OFF

Operation of the Bolt Lock

The Thompson rifle is designed so that the bolt remains open after the last shot has been fired, provided the rifle is fitted with a stick magazine (the bolt closes after the last round when equipped with the drum magazine). When the magazine is empty, a protrusion on the rear of the stick magazine follower actuates the bolt lock which is designed to retain the bolt in its rearward position.

To actuate the bolt lock without a magazine, a trip lever in the frame needs to be manually moved by the shooter. The lever is located at the top of the guide rails where the magazine is inserted. With the safety lever in the "FIRE" position, draw the bolt fully rearward and push up on the lever, letting the bolt slowly go forward until it locks in place.





THE BOLT LOCK IS NOT A SAFETY DEVICE. IT SHOULD NEVER BE USED TO HOLD THE BOLT BACK WHEN THERE ARE CARTRIDGES IN THE MAGAZINE.

The only purpose of the bolt lock is for convenience in the rapid changing of magazines and for holding the bolt in its rearward position when the rifle is unloaded for cleaning and inspection.

To release the bolt, with the safety lever in the "SAFE" position, simply draw the bolt back and let go; the bolt will go forward.



THE BOLT IS UNDER HEAVY SPRING TENSION AND CAN INJURE FINGERS WHEN IT SLAMS SHUT.

Ammunition



FOR PROPER FUNCTIONING IN ALL THOMPSON .45 CALIBER GUNS WE RECOMMEND THE USE OF 230 GRAIN .45 ACP BALL AMMUNITION ONLY.



Recommended Ammunition
230 grain .45 ACP BALL ammunition



AMMUNITION (CARTRIDGE) NOTICE

Death, serious injury, and damage can result from the use of wrong ammunition, bore obstructions, powder overloads, or incorrect cartridge components. Even the strongest firearm can be "blown up" as a result of excess pressure. Always wear shooting glasses and hearing protectors. We specifically disclaim responsibility for any damage or injury whatsoever occurring in connection with, or as the result of, the use in Thompson firearms of cartridges other than those for which the firearm was originally chambered.



LEAD EXPOSURE

Discharging firearms in poorly ventilated areas, cleaning firearms, or handling ammunition may result in exposure to lead and other substances known to the state of California to cause birth defect, reproductive harm, and other serious physical injury. Have adequate ventilation at all times. Wash hands thoroughly after exposure.

Magazines - Stick Magazine and Drum Magazines

Loading the Stick Magazine

Use only factory loaded ammunition of the proper caliber manufactured to US Industry and SAAMI specifications, referenced by markings on receiver. (See Notice and Warnings in other sections of this manual pertaining to Ammunition).

To load the stick magazine, align each cartridge with the bullet forward (pointing toward the larger opening in the front of the magazine body) and push downward until the cartridge snaps into place. Do not attempt to load more than the designated number of cartridges for which the magazine has been designed.



DAMAGED, NON-STANDARD, OR IMPROPERLY ASSEMBLED MAGAZINES SHOULD NEVER BE USED. THEY CAN CAUSE A MALFUNCTION, SERIOUS INJURY OR DEATH.

Inserting the Stick Magazine

The magazine may be inserted with the bolt either in the closed or open position (see Operation of Bolt Lock).



ALWAYS CONFIRM THE SAFETY LEVER IS IN THE "SAFE" POSITION WHEN INSERTING OR REMOVING THE MAGAZINE.

While pushing up on the magazine catch, insert the magazine into the bottom of the guide rails in the receiver. (see picture) Push the magazine all the way up the guide rails and then release the magazine catch. A stud in the magazine catch should mate with the hole in the magazine tube and lock the magazine in place. Check to be sure that the magazine is securely latched in place. It may be necessary to bump the magazine bottom with the heel of your hand to securely lock magazine.



Removing the Stick Magazine

To remove the magazine, simply push up on the magazine latch while grasping the bottom of the magazine and pull down. To minimize the possibility of damage and malfunctions, do not let the magazine drop to the ground.

Loading the 10 round (X-Type) and 50 round (L-Type) Drum Magazines

The Thompson Drum magazines are designed to fit all Thompson 1928 full-auto models, 1927A-1 Deluxe model both steel and aluminum receivers and the 1927A-1 Commando model. The drum magazine will not fit the Thompson M1 models because the M1 receivers do not have the required slots to accept the drum magazines.

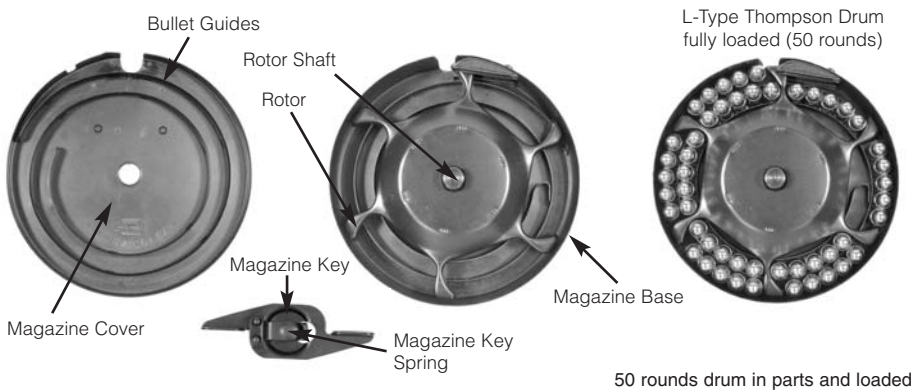
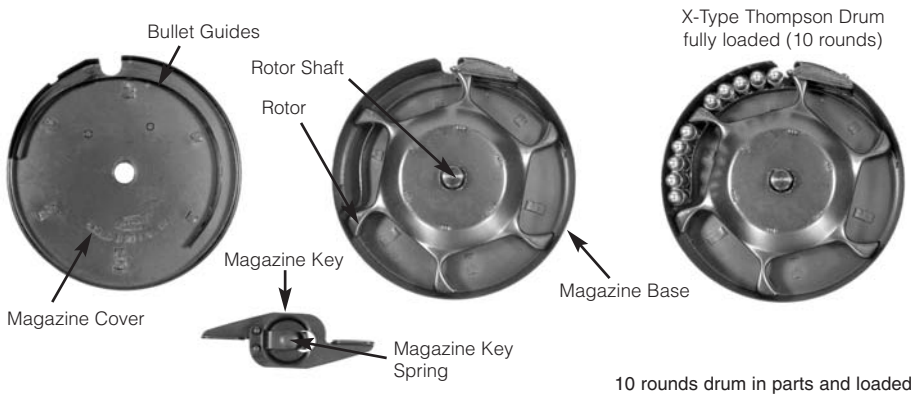

1. While lifting the magazine key spring, slide the magazine key off the rotor shaft and magazine cover. Remove cover from magazine base.

2. Place 230 grain hardball ammo with the nose of the bullets pointing up starting at 12 o'clock position in magazine base loading counter-clockwise. For the 50 round (L-Type) drum, fill each of the ten sections of the rotor with five rounds each until fully loaded. For the 10 round (X-Type), fill the one ten round section until fully loaded.



WARNING: WHERE LOOPED END OF BULLET GUIDE ENDS, DO NOT LOAD IN THIS AREA AS JAMS WILL OCCUR WHEN ROTOR TURNS, RESULTING IN POSSIBLE INJURY OR DEATH.

3. When the drum is fully loaded, replace the cover and magazine key. The cuts in the rotor shaft need to be aligned with the magazine key; while exerting downward pressure on the cover, slide the key fully onto the rotor shaft. For the L-Type 50 round drum, wind the key 9-11 clicks as stated on the magazine cover. For the X-type 10 round drum, wind the key 4-6 clicks.



WARNING: TO AVOID PERSONAL INJURY, DO NOT WIND MORE THAN THE STATED AMOUNT OR AFTER ANY ROUND HAS BEEN FIRED.

4. To unload, hold the drum upside down and press bullets out forward one by one through the mouth of the magazine until empty.



WARNING: DO NOT OPEN COVER WHEN LOADED AND ROTOR IS UNDER TENSION AS DAMAGE OR PERSONAL INJURY MAY RESULT.

5. To insert or remove the drum magazine from the firearm, the bolt must be locked back. Please refer to page 9 under "Operation of the Bolt Lock"

6. Insert the drum in the slots in the receiver from the left side of the firearm until the magazine catch locks in place. The drum may fit tightly the first few times.

7. After the last round has been fired from the drum magazine the bolt will close. In order to remove the drum magazine from the firearm the bolt must be locked back. To assist in locking the bolt back each drum from Kahr Arms includes a "third hand" (see picture). This device is inserted into the guide rails for the stick magazine while pulling back on the magazine catch. The stud in the magazine catch should fit in the opening on the third hand. The third hand can now be pushed fully upward against the trip lever while pulling all the way back on the bolt handle. Now release the bolt handle at the end of its travel and it will be locked back. Remove the third hand from the guide rails. While pushing up on the magazine catch the drum magazine can be slid out of the slots from the left side of the firearm.

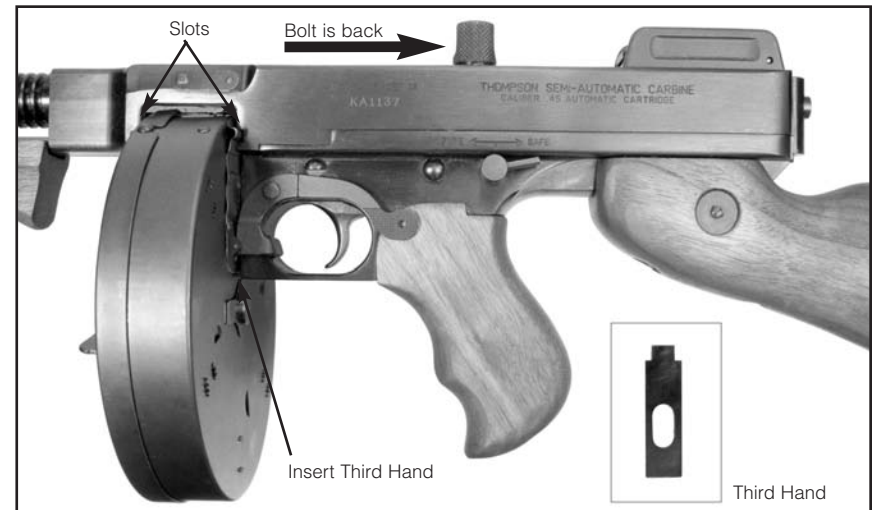

Loading and Firing the Thompson

Practice this important aspect of firearm handling with an unloaded rifle until you can perform each of the steps described below. This procedure begins with an empty rifle with the magazine out.

1. Be certain the muzzle is pointed in a safe direction.
2. Before inserting the loaded magazine lock back the bolt according to the instructions on page 9. Verify the chamber is empty and move the safety lever to the "SAFE" position.
3. Insert the loaded magazine into the receiver and immediately draw the bolt handle all the way to the rear and release it, allowing the bolt to snap forward under full spring tension. A cartridge will be stripped from the magazine and chambered.
4. The rifle is now cocked and a loaded cartridge is in the chamber. Visually confirm that the safety lever is in the "SAFE" position.
5. When you are ready to fire the rifle move the safety lever to the "FIRE" position. Never touch the trigger until you are ready to fire. Always keep the safety lever in the "SAFE" position until you are actually firing the firearm.
6. The rifle will fire one shot each time the trigger is pulled until the magazine is empty. Each time the bolt is pushed rearward by the energy of the cartridge, a spent case is ejected, the firearm is recoiled and a new cartridge is chambered from the magazine into the chamber.
7. Immediately following the firing of a shot if another shot is not to be fired at once, put the safety lever in the "SAFE" position while the rifle is still pointing in a safe direction down range. The safety lever should be moved to the "SAFE" position as soon as firing is completed.
8. When the last cartridge in the magazine has been fired the bolt lock will remain open when using stick magazines. The bolt will close on a drum magazine. Before following the procedures on page 13 to remove the drum magazine manually pull back on the bolt handle just enough to visually inspect the chamber to confirm it is empty. Always confirm that no bullets remain in the opening of the drum magazine.

To Unload the Thompson

1. Always keep the muzzle pointed in a safe direction at all times and keep the fingers outside the trigger guard.



WARNING: THE UNLOADING SEQUENCE MUST BE FOLLOWED EXACTLY AS SPELLED OUT. FAILURE TO DO SO CAN RESULT IN THE RIFLE'S CHAMBER BECOMING UNINTENTIONALLY LOADED WITH A CARTRIDGE.

2. Push up on the magazine catch and remove the magazine.



WARNING: EVEN THOUGH THE MAGAZINE HAS BEEN REMOVED A CARTRIDGE REMAINING IN THE CHAMBER CAN STILL BE FIRED. ALWAYS VISUALLY CHECK THE CHAMBER.

3. Pull the bolt handle all the way to the rear, extracting and ejecting the cartridge in the chamber.
4. Visually confirm the chamber is empty. A safe rifle is one in which the bolt is open and the chamber and magazine are empty and safety is on.

Disassembly of the Semi-Auto Thompson for Routine Cleaning



WARNING: MAKE SURE YOUR THOMPSON RIFLE IS UNLOADED BEFORE STARTING THIS PROCEDURE.

Takedown procedures for all Thompson semi-autos are the same.

1. With the rifle pointing in a safe direction, safety lever in the "SAFE" position, remove the magazine by pushing up on the magazine catch and pulling the magazine out of the rifle.

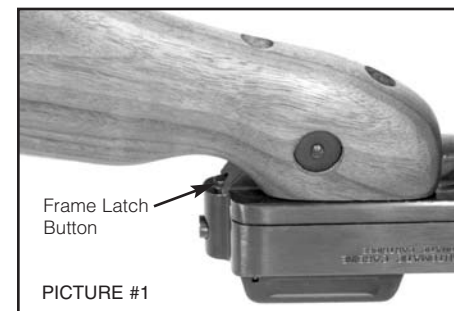

2. Confirm once again that the rifle is unloaded by visually checking the chamber. Before disassembly the bolt should be in the forward position, firing pin in the fired position and the safety lever in the "FIRE" position.

3. With the firearm upside down and using a flat-blade screwdriver with a 1/8" width blade depress the frame latch button in the rear bottom portion of the receiver. (See PICTURE #1) At the same time pull the frame to the rear (new guns may be tight). Once the frame is clear of the button you can remove the screwdriver and continue pulling the frame to the rear. About half way back the frame latch button will catch

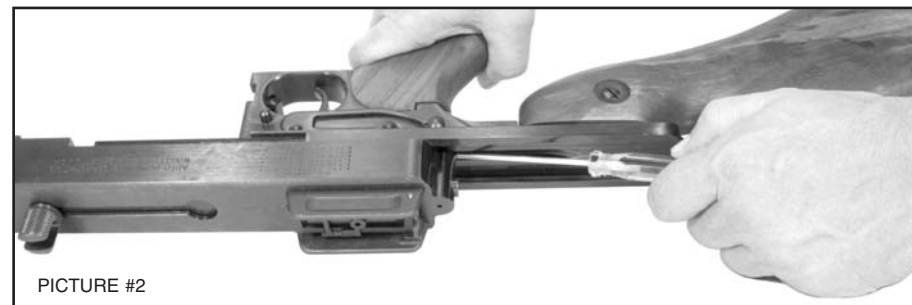

on the frame. Using the same flat-blade screwdriver depress the frame latch button again and remove the frame the rest of the way off the receiver. (See PICTURE #2) Care should be taken not to misplace the frame latch button should it drop out of the receiver.

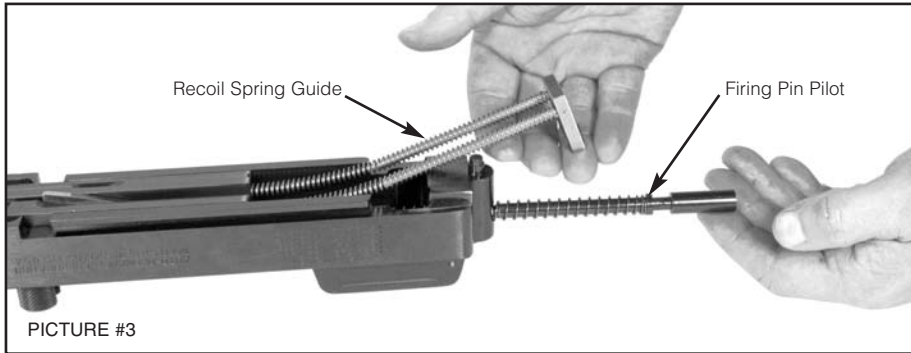

4. While the receiver is still upside down, the internal parts of the receiver can be removed by pulling up on the recoil spring guide and springs. (See PICTURE #3) It may be helpful to use the flat-blade screwdriver to take pressure off the recoil spring guide before lifting the recoil spring guide out of the receiver. The recoil spring guide is under spring tension so care should be taken when the spring guide clears the receiver. After removing the recoil spring guide and springs the firing pin pilot and spring will come out of the hole in the rear of the receiver.

5. Holding the bolt forward with the firearm upside down point the muzzle upwards so that the hammer slides free of the bolt handle. Remove the bolt handle from the hole in the top of the receiver or from the side on the M1. The bolt can now be removed from the receiver by sliding the bolt all the way to the rear and lifting it clear of the receiver.

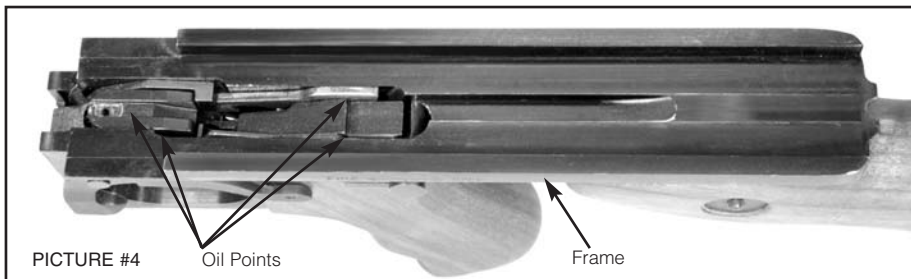

6. Further disassembly of the frame is not normally required for routine cleaning. A light coat of oil on pivot points and sliding surfaces between the bolt and receiver is recommended. (See PICTURE #4)

WARRANTY IS VOIDED IF PIVOT PLATE IS REMOVED WITH FRAME ON RECEIVER.

Reassembly of the Semi-Auto Thompson



WARNING: ONCE AGAIN MAKE SURE YOUR THOMPSON RIFLE AND MAGAZINE IS UNLOADED BEFORE STARTING THIS PROCEDURE.

1. The bolt can be re-inserted into the receiver by placing it in the rear of the receiver and sliding it forward through the hole in the front of the receiver.

2. Insert the bolt handle into the top of the receiver (side of the receiver on the M1) by lining up the holes in the bolt and the receiver. While the receiver is upside down the hammer can be inserted into the hole in the rear of the bolt.

3. The firing pin pilot and spring can now be inserted into the hole in the rear of the receiver and the spring should go partially into rear of the bolt.

4. With the bolt fully forward in the receiver the recoil spring guide and springs can now be installed by first inserting the two springs into the two matching holes in the top rear of the bolt. Push the recoil spring guide forward under spring tension taking care should the spring guide slip and come flying out. Once the recoil spring guide clears the back of the receiver insert the spring guide into the receiver being careful not to make contact with the firing pin pilot or spring.

5. Push and hold the back of the firing pin pilot so that the small diameter portion of the pilot lines up with the cut-out on the recoil spring guide. Now push all the way down on the recoil spring guide so that it slips completely onto the firing pin pilot. At this point the recoil spring guide should be flush with the receiver.



6. While the receiver is upside down line up the frame slots onto the rear portion of the rails on the receiver and push the frame fully onto the receiver until the frame has cleared the frame latch button and locks in place. (See PICTURE #5)

Stick Magazine Inspection and Care

Check your stick magazine frequently to insure it is in proper working condition. The follower must move freely and have adequate spring tension so that each cartridge is quickly lifted to the feeding position.

To check the spring tension, load one cartridge into the magazine and then firmly press against the cartridge case. Remove your finger quickly. The cartridge should instantly and fully move into the feeding position. If it does not, the magazine should be cleaned. If cleaning does not restore proper spring tension do not use the magazine.

Should cleaning be necessary use a high quality gun cleaning solution that will not rust the metal. The magazine may be disassembled by placing a small flat-blade screwdriver into the slot in the magazine baseplate and carefully lifting the tab to clear the magazine tube. Next carefully use the screwdriver blade to start sliding the magazine baseplate off the tube by inserting the blade between the baseplate and front of the magazine tube. After the initial gap is opened up between the baseplate and the tube you can use your thumbs to complete sliding the baseplate clear of the tube.

CAUTION: The magazine spring is under tension and could come out causing injury.

To reassemble insert the magazine follower and spring. The spring is uni-directional and can be installed either way in the magazine tube. While compressing the spring into the tube slide the magazine baseplate on from the rear. Finally insert the screwdriver blade into the tab and bend the tab down so it is flush with the rear of the magazine tube.

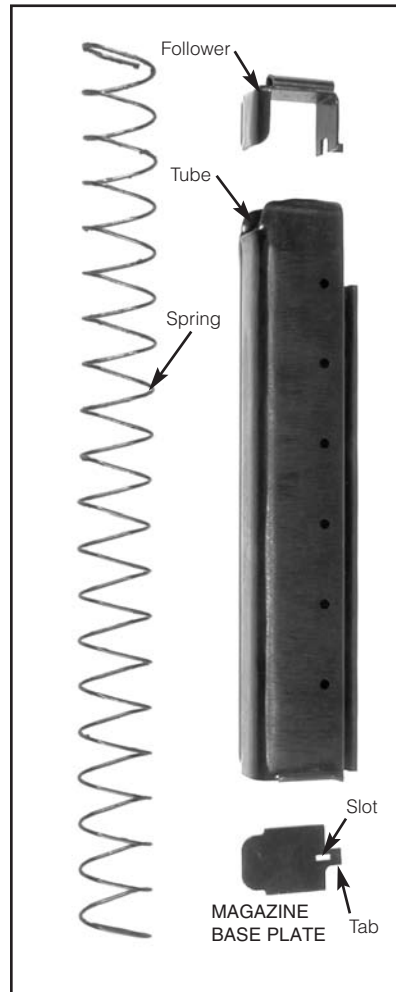

BEFORE CLEANING, BE CERTAIN THE RIFLE AND ITS MAGAZINE CONTAIN NO CARTRIDGES.

At regular intervals, or whenever the rifle has been exposed to sand, dust, extreme humidity, condensation, immersion in water, or other adverse conditions, disassemble, clean and oil it. Proper periodic maintenance is essential to the reliable functioning of any firearm.

To clean the rifle, proceed as follows:

1. Disassemble (field-strip) the rifle to the extent described on page 15.
2. Using a cleaning rod, run a patch wetted with a high quality gun cleaning solution through the bore several times. Then attach a bristle brush wetted with a high quality gun cleaning solution to the rod and run it back and forth the full length of the bore and chamber. Clean bore with dry patches and examine. Bore fouling can contribute to reduced accuracy, and grease accumulation in the chamber can interfere with proper feeding of cartridges from the magazine.
3. Using a high quality cleaning powder on a clean patch or bristle brush, remove powder residue from all components of the mechanism. After cleaning, run a dry patch through the bore, then follow with a patch that is very lightly oiled. Wipe all surfaces clean with cloth, then wipe all surfaces with a patch or cloth that has been very lightly oiled.
4. NOTE: Only a light application of oil is needed to provide adequate lubrication of moving parts and to prevent rust. (See PICTURE #4, oil points, on page 16) Excess accumulations of oil tend to attract particles of dust and dirt and may congeal in cold weather which can interfere with the safe and reliable function of the rifle.



LUBRICATION

FIRING A RIFLE WITH OIL, GREASE, OR ANY OTHER MATERIAL EVEN PARTIALLY OBSTRUCTING THE BORE MAY RESULT IN DAMAGE TO THE RIFLE AND SERIOUS INJURY TO THE SHOOTER AND THOSE NEARBY. DO NOT SPRAY OR APPLY LUBRICANTS DIRECTLY ON AMMUNITION. IF THE POWDER OF A CARTRIDGE IS AFFECTED BY THE LUBRICANT, IT MAY NOT BE IGNITED, BUT THE PRIMER FIRING MAY PUSH THE BULLET INTO THE BORE WHERE IT MAY BE LODGED. FIRING A SUBSEQUENT BULLET INTO THE OBSTRUCTED BORE MAY DAMAGE THE RIFLE AND CAUSE SERIOUS INJURY OR DEATH TO THE SHOOTER AND THOSE NEARBY. USE LUBRICANTS PROPERLY. YOU ARE RESPONSIBLE FOR THE PROPER CARE AND MAINTENANCE OF YOUR FIREARM.



DAMAGED, NON-STANDARD, OR IMPROPERLY ASSEMBLED MAGAZINES SHOULD NEVER BE USED. THEY CAN CAUSE A MALFUNCTION, SERIOUS INJURY OR DEATH.



WARNING!

BEFORE SHIPPING ANY FIREARM, BE ABSOLUTELY CERTAIN THAT IT AND ITS MAGAZINE ARE UNLOADED.
DO NOT SHIP CARTRIDGES WITH A FIREARM.
IMPROPER FITTING PARTS MAY RESULT IN
A DANGEROUS MALFUNCTION, DAMAGE TO THE FIREARM,
AND INJURY TO THE SHOOTER AND OTHER PERSONS.

It is the responsibility of the purchaser to be absolutely certain that parts ordered from the factory are correctly fitted and installed. The purchaser and installer of parts must accept full responsibility for the correct adjustment and functioning of the firearm after such installation.

Ordering Parts and Accessories

Order parts by Part Name and Part Number refer to page 24 (for T1, T5, Commando and T1SB) and page 26 (for M1 and M1SB). Please refer to the separate order sheet and price list included with the firearm packaging to place orders. Orders for Thompson parts can be processed by mail, fax or at www.tommygunshop.com. We do not process phone orders. Prices and availability can be verified by phone. When ordering specify the model, caliber, finish and entire serial number of the firearm - including all letters and numbers. Note: many parts are common to all firearms regardless of model finish.

Order accessories by Item Name and Item Number. All parts and accessory orders should be mailed or faxed to:

Kahr Arms - Parts Dept.
130 Goddard Memorial Drive, Worcester, MA 01603
Phone: (508) 795-3919 / Fax: (508) 795-7046

Payment for Parts and Accessories

All orders require prepayment - by check, money order or credit card authorization. Parts and accessories can be ordered online at www.tommygunshop.com. KAHR ARMS cannot offer individuals open account or COD requests.

Include \$6.00 for shipping and handling on parts orders totaling \$50.00 or less. Include \$9.00 on parts orders totaling more than \$50.00.



WARNING!

TO AVOID PERSONAL INJURY A FIREARM CONTAINING MODIFIED, BROKEN, BADLY WORN OR MALFUNCTIONING PARTS SHOULD NEVER BE FIRED!

Shipping Firearms For Service

Thompson rifles returned to the factory for service or repair should be sent to:

Kahr Arms - Service Dept.
130 Goddard Memorial Drive
Worcester, MA 01603

Contact Kahr Arms Customer Service Dept. at: (508)795-3919 to receive a "Return Authorization" Number before shipping a firearm to the factory. Firearms shipped to the factory must be sent prepaid. THE KAHR SERVICE DEPARTMENT CAN NOT ACCEPT COLLECT SHIPMENTS.

The Federal Firearm Control Act does not prohibit an individual from shipping a firearm directly to the manufacturer for service or repair. However, some states or localities prohibit this. If you live in such a location, have a Federally Licensed Firearms dealer ship the firearm. It will be returned to the dealer after being serviced.

Enclose a letter that includes reference to the factory "Return Authorization" Number, your name, address, telephone number, and serial number and model of the firearm. Describe in detail the trouble you have experienced with your firearm, or the work you wish to have done. Stating only that the firearm "needs repair" is inadequate information. Please enclose copies of any previous correspondence.

Please do not include slings, or special accessories with any firearm being shipped to the factory for service.

Service work performed, other than approved Warranty repairs, will carry a minimum charge of \$15.00 plus a \$15.00 return shipping and handling charge.

Retain your tracking number when shipping firearms for repair. This will allow you to track the status of your firearm shipment either by phone or the website of the carrier.

Please allow 21 days for the return of a long gun.

THE BASIC RULES OF SAFE FIREARMS HANDLING

We believe that Americans have a right to purchase and use firearms for lawful purposes. The private ownership of firearms in America is traditional, but that ownership imposes the responsibility on the firearm owner to use his firearm in a way which will ensure his own safety and that of others. When firearms are used in a safe and responsible manner, they are a great source of pleasure and satisfaction, and represent a fundamental part of our personal liberty.

Firearms do not cause accidents! Firearms accidents are almost always found to have been the result of carelessness, or ignorance on the part of the shooter of the basic rules of safe firearm handling.

The following rules must be observed by firearm users at all times. Safe firearm handling is not just desirable, it is absolutely essential to your safety, the safety of others, and the continuation of firearm ownership and sport shooting as we know it today.

1. ALWAYS TREAT EVERY FIREARM AS IF IT WERE LOADED.

2. LEARN THE MECHANICAL AND HANDLING CHARACTERISTICS OF THE FIREARM YOU ARE USING.

Not all firearms are the same. The method of carrying and handling firearms varies in accordance with the mechanical provisions for avoiding accidental discharge and the various proper procedures for loading and unloading. No person should handle any firearm without first having thoroughly familiarized himself with the particular type of firearm he is using, and with safe firearm handling in general.

3. ALWAYS KEEP THE MUZZLE POINTED IN A SAFE DIRECTION.

Be sure of the bullet stop or area behind your target, even when dry-firing. Always be sure the area beyond your target is safe. Never let the muzzle of a firearm point at any part of your body or at another person. This is particularly important when loading or unloading a firearm. In the event of an accidental discharge, no injury can occur as long as the muzzle is pointing in a safe direction. A safe direction means a direction which will not permit a discharged bullet to strike a person, or to strike an object from which the bullet may ricochet.

A safe direction must take into account the fact that a bullet may penetrate a wall, ceiling, floor, window, etc., and strike a person or damage property. Make it a habit to know exactly where the muzzle of your firearm is pointing whenever you handle it, and be sure that you are always in control of the direction in which the muzzle is pointing, even if you fall or stumble. Keep your finger off the trigger until you are ready to shoot.

4. FIREARMS SHOULD BE UNLOADED WHEN NOT IN USE.

Firearms should be loaded only when you are in the field or on the target range or shooting area, ready to shoot. Firearms and ammunition should be securely locked in a rack, cabinets or a safe when not in use. Ammunition should safely be stored separate from firearms in a locked container. Store your firearms out of sight of visitors and children. It is the firearm owner's responsibility to be certain that children and persons unfamiliar with firearms cannot gain access to firearms, ammunition, or components.

5. BE SURE THE BARREL IS CLEAR OF OBSTRUCTIONS BEFORE SHOOTING.

Even a bit of mud, snow or excess lubricating oil or grease in the bore may cause the barrel to bulge, or even burst on firing, and can cause serious injury to the shooter and bystanders. Be sure that you are using ammunition of the proper caliber and loading designated on the receiver for the firearm you are using. If the report or recoil on firing seems weak, or doesn't seem quite right, CEASE FIRING IMMEDIATELY, unload your firearm, and check to be sure that no obstruction has become lodged in the barrel. Never try to shoot out an obstruction! Have the firearm inspected by a professional gunsmith or return it to the factory.

6. BE SURE OF YOUR TARGET BEFORE YOU SHOOT.

Don't shoot unless you know exactly where your bullet is going to strike. Be sure of the bullet stop behind your target, even when dry-firing with an unloaded firearm. If you are in the field hunting, do not fire at a movement or noise. Take the time to be absolutely certain of your target and what is beyond before you pull the trigger.

7. WEAR SHOOTING GLASSES AND HEARING PROTECTORS WHEN YOU SHOOT.

All shooters should always wear protective shooting glasses and adequate hearing protectors when shooting. Exposure to shooting noise can damage hearing, and the use of adequate eye protection when shooting is essential.

8. NEVER CLIMB A TREE OR FENCE WITH A LOADED FIREARM.

Put the firearm down carefully before climbing a fence, and unload it before climbing or descending a tree or jumping over a ditch or other obstruction. Never pull or push a loaded firearm toward yourself or another person. When in doubt always unload your firearm!

9. DON'T SHOOT AT A HARD SURFACE, OR AT WATER.

Bullets can glance off many surfaces like rocks or the surface of water and travel in unpredictable directions with considerable velocity.

10. NEVER TRANSPORT A LOADED FIREARM.

Firearms should always be unloaded before being placed in a vehicle. A suitable carrying case or scabbard with a lock should be used to carry an unloaded firearm to and from the shooting area.

11. NEVER USE ALCOHOLIC BEVERAGES WHEN SHOOTING OR HANDLING FIREARMS.

Don't drink when handling firearms. Handling firearms while under the influence of alcohol in any form, or medications that could affect your judgement or co-ordination, constitutes a criminal disregard for the safety of others.

12. FIREARMS SHOULD BE STORED UNLOADED AND LOCKED IN A LOCATION THAT IS BOTH SEPARATE FROM THEIR AMMUNITION AND INACCESSIBLE TO CHILDREN AND OTHER UNAUTHORIZED PERSONS.

MODELS: T1, T5, T1-C (Commando) and T1SB PARTS LIST

Key Description	Parts #
1. Barrel, Finned & Threaded 16.5"	27-1
Barrel, Finned & Threaded 10.5"	TSBT1
2. Bolt	27-3
3. Bolt Handle	27-4
4. Buttplate	27-5
5. Buttplate Screw, Large	27-6
6. Buttplate Screw, Small	27-7
• Buttstock Complete with All Metal	27-8
7. Buttstock, (Wood Only)	27-8A
8. Buttstock, Retaining Screw, Large	27-9
9. Buttstock, Retaining Screw, Small	27-10
10. Buttstock Reinforcing Nut & Bolt	27-11
11. Compensator, Less Front Sight	27-12
12. Disconnect	27-13
13. Extractor	27-14
14. Ejector	27-15
15. Firing Pin	27-16
16. Firing Pin, Retaining Pin (2 Req'd)	27-17
17. Firing Pin, Retracting Pin	27-18
18. Firing Pin Spring	27-19
19. Firing Pin Pilot	27-20
20. **Foregrip, Vertical	27-21

* FFL DEALERS ONLY

** 3/4" SLOT ONLY FOR GRIPMOUNTS

21. Foregrip, Vertical Screw	27-22
22. Frame	27-25
23. Frame Latch Button	27-26
24. Frame Latch Spring	27-27
25. Front Sight for Compensator	27-29
26. Gripmount	27-30
27. Hammer	27-31
28. Magazine, 30 Round	27-33
(Limited Supply)	
29. Lifter	27-34
30. Lifter Spring	27-35
31. Magazine Catch	27-36
32. Magazine Catch Spring	27-37
33. Pawl	27-38
34. Pawl Spring	27-39
35. Pivot Plate	27-40
36. Rear Grip	27-41
37. Rear Grip Screw	27-42
38. *Receiver	27-43
• Rear Sight Leaf Complete	27-45
(Includes: Parts 27-45A thru 27-45G)	
39. Rear Sight Leaf	27-45A
40. Rear Sight Leaf Pin	27-45B
41. Rear Sight Leaf Slide	27-45C
42. Rear Sight Leaf Latch	27-45D
43. Rear Sight Leaf Latch Pin	27-45E

44. Rear Sight Leaf Slide Stop Pin	27-45F
45. Rear Sight Leaf Side Latch Spg	27-45G
46. Rear Sight Base	27-46
47. Rear Sight Plunger Spring	27-47
48. Rear Sight Plunger	27-48
49. Rear Sight Screws (4)	27-49
• Rear Sight Assembly Complete	27-RSA
(Includes: Parts 27-45A thru 27-49)	
50. Recoil Spring (2)	27-50
51. Recoil Spring Guide	27-51
52. Safety Lever	27-52
53. Sear Block	27-53
54. Sear Block Spring	27-54
55. Sling Swivel	27-55
56. Sling Swivel Screws (2)	27-56
57. Trigger	27-57
58. Trigger Spring	27-58
59. Trip Lever	27-59

Parts unique to T1-C (Commando)

60. **Foregrip, Horizontal	27-23
61. Foregrip, Horizontal Screw	27-24
62. Sling Swivel	27-55
63. Sling Swivel Screws (2)	27-56

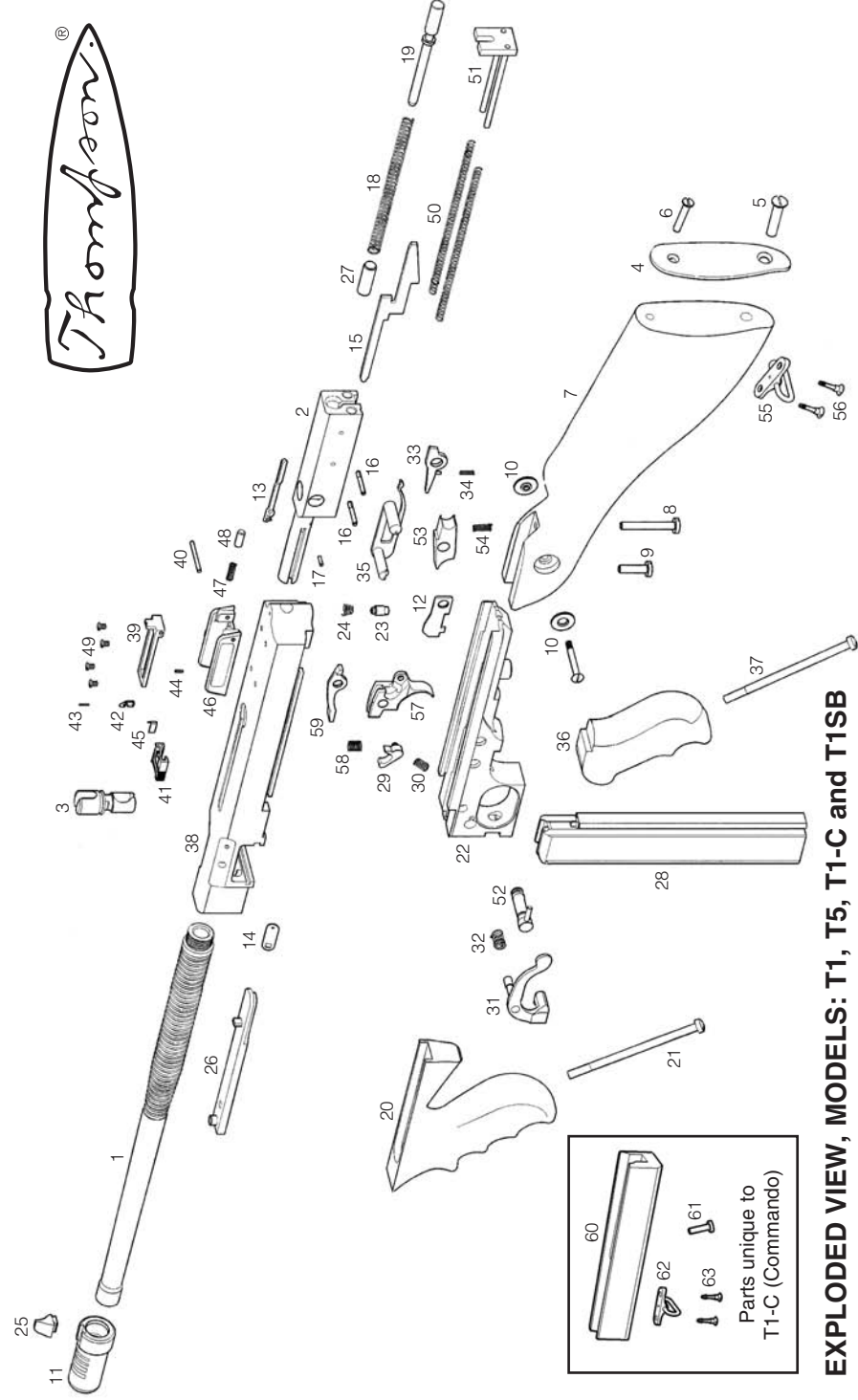

EXPLODED VIEW, MODELS: T1, T5, T1-C and T1SB

MODELS: TM1, TM1C and M1SB PARTS LIST

Key Description	Parts #	Foregrip, Horizontal Screw	Sear Block
1. Barrel, 16.5" Smooth	M1-2	27-24	27-53
Barrel, 10.5" Smooth	TSBM1	M1-25	27-54
2. Bolt	M1-3	27-26	27-55
3. Bolt Handle	M1-4	27-27	27-56
4. Extended Bolt Handle (Must be ordered separately)	M1-4A	M1-28	27-57
5. Buttplate	27-5	27-30	27-58
6. Buttplate Screw, Large	27-6	27-31	27-59
7. Buttplate Screw, Small	27-7	27-33	
• Buttstock Complete with All Metal	27-8		
8. Buttstock, (Wood Only)	27-8A	27-34	
9. Buttstock, Retaining Screw, Large	27-9	27-35	
10. Buttstock, Retaining Screw, Small	27-10	27-36	
11. Buttstock Reinforcing Nut & Bolt	27-11	27-37	
12. Disconnect	27-13	27-38	
13. Extractor	27-14	27-39	
14. Ejector	M1-15	27-40	
15. Firing Pin	27-16	27-41	
16. Firing Pin, Retaining Pin (2 Req'd)	27-17	27-42	
17. Firing Pin, Retracting Pin	27-18	M1-43	
18. Firing Pin Spring	27-19	M1-44	
19. Firing Pin Pilot	27-20	27-49	
20. **Foregrip, Horizontal	27-23	27-50	
		27-51	
		27-52	

* FFL DEALERS ONLY

** 3/4" SLOT ONLY FOR GRIPMOUNTS

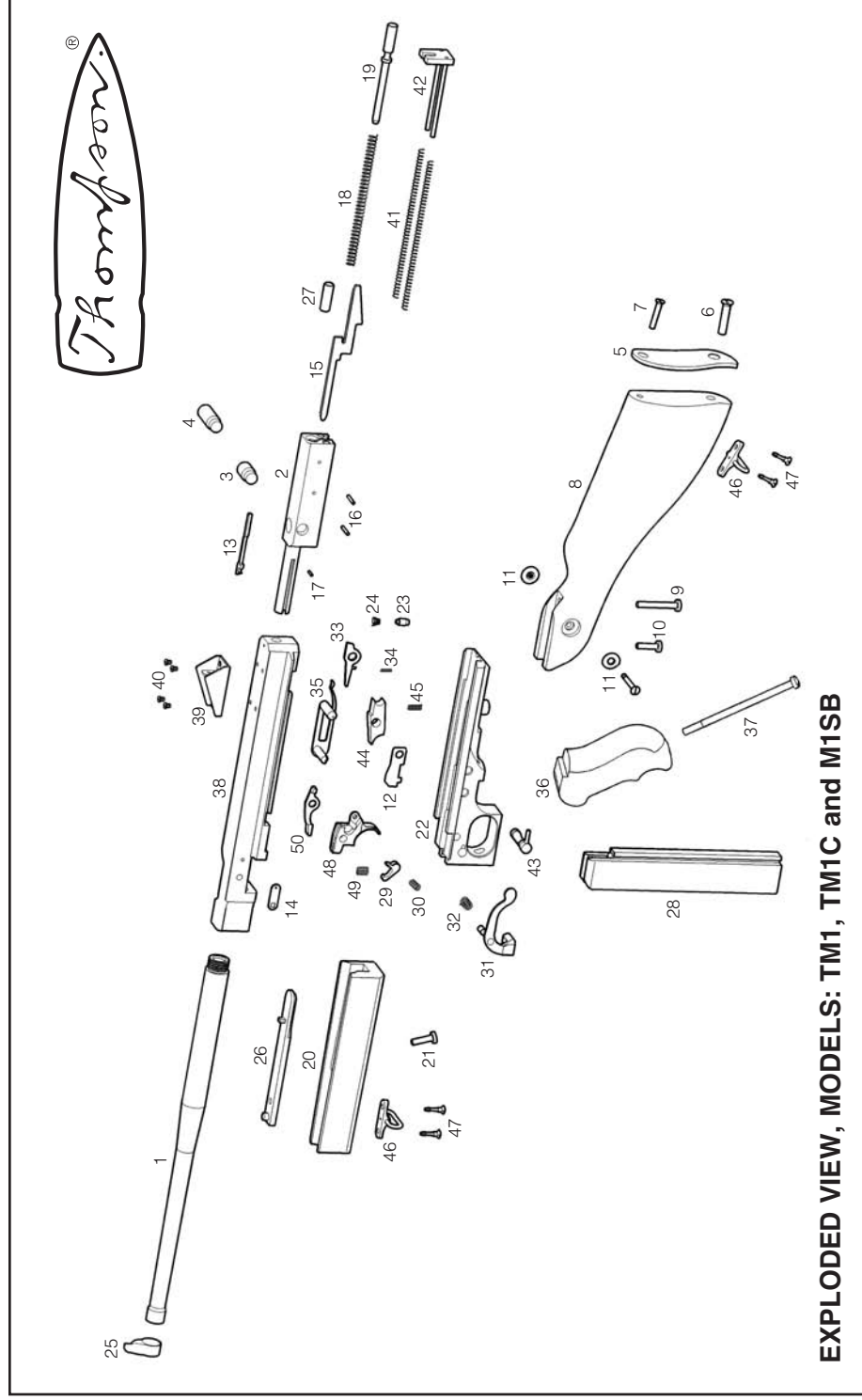

EXPLODED VIEW, MODELS: TM1, TM1C and M1SB